

FEATURES

- 30A to 80A continuous current capacity
- Automotive - oriented design
- Fully standardized QC size and layout
- Plastic cover for rough environment protection

TYPICAL AUTOMOTIVE APPLICATIONS

- Head lights
- Fog lamp
- Signal horn
- Blower motor control
- Starter relay
- Radiator cooling fan
- Power window
- ABS system
- Start bypass relay

CONTACT DATA

HG4185A

Form		1 Form A (1H, 1HS)	1 Form C (1Z)
Max. Switching Current	Make	120A	NO120A/NC 45A
	Break	40A	NO40A/NC 30A
Material		AgNi10	
Initial Contact Resistance		100 mΩ max. at 0.1A, 6VDC	
Max. Switching Voltage		See Curve 1, current dependent	
Max. Continuous Current		30A	NO30A/NC 30A
Min. Load		0.1A, 12VDC	
Service Life	Mechanical	10 ⁷ ops.	
	Electrical	2 x 10 ⁵ ops, see Note 4	

HG4185B

Form		1 Form A (1H, 1HS)	1 Form C (1Z)
Max. Switching Current	Make	120A	NO120A/NC 45A
	Break	60A	NO60A/NC 40A
Material		AgCdO	
Initial Contact Resistance		100 mΩ max. at 0.1A, 6VDC	
Max. Switching Voltage		See Curve 1, current dependent	
Max. Continuous Current		60A	NO60A/NC 40A
Min. Load		0.5A, 12VDC	
Service Life	Mechanical	10 ⁷ ops.	
	Electrical	2 x 10 ⁵ ops, see Note 4	

HG4185C

Form		1 Form A (1H)	1 Form C (1Z)
Max. Switching Current	Make	240A	NO240A/NC 180A
	Break	80A	NO80A/NC 60A
Material		AgSnOInO	
Initial Contact Resistance		100 mΩ max. at 0.1A, 6VDC	
Max. Switching Voltage		See Curve 2, current dependent	
Max. Continuous Current		80A	NO80A/NC 60A
Min. Load		0.5A, 12VDC	
Service Life	Mechanical	10 ⁷ ops.	
	Electrical	10 ⁵ ops, see Note 4	

HG4185A/B/C

COIL DATA

Coil Voltage Code	Nominal Voltage (VDC)	Resistance (Ω) $\pm 10\%$	Must Operate Voltage max. (VDC)	Allowable Voltage (VDC)	Must Release Voltage min. (VDC)
006	6	22	3.6	10.1	0.6
012	12	90	7.2	20.5	1.2
024	24	330	14.3	39.1	2.4

CHARACTERISTICS

Operate Time	7 ms. typical
Release Time	2 ms. typical
Insulation Resistance	100 M Ω , at 500 VDC, 50%RH
Dielectric Strength	500 Vrms, 1 min.
Shock Resistance	20 g, 11ms.
Vibration Resistance	10-40Hz: DA 1.27mm; 40-70Hz: 5 g; 70-100Hz: DA 0.5mm; 100-500Hz: 10 g.
Drop Resistance	1 M height drop on concrete
Power Consumption	1.6W, un-suppressed; 1.81W, with resistor
Ambient Temperature	-40°C to 125°C operating; -40°C to 155°C storage
Weight	35 g, approx.

ORDERING DESIGNATION

Example:	HG4185	C /	012	R -	1H	9	-1
Model							
Rating Code A: 20A; B: 40A; C: 80A							
Coil Voltage Code							
Paralleled Component Nil: Nil; R: Resistor; D: Diode (+) 85-86 (-); DR: Diode Reversed (-) 85-86 (+)							
Contact Form 1H: 1 Form A; 1HS*: 1 Form A with Double 87 Terminals; 1Z: 1 Form C							
Mounting Version Nil: Plug-In; 4: PCB; 9: Molded Bracket; 9M1: Metal Bracket; 9M2: Bent Metal Bracket; 9S1: Skirted Cover + Metal Bracket; 9S2: Skirted Cover + Bent Metal Bracket							
Version 1: Sealed (only available for Plug-In, PCB and Molded Bracket mounting)							

*: Available for HG4185A, HG4185B only.

REFERENCE CURVES

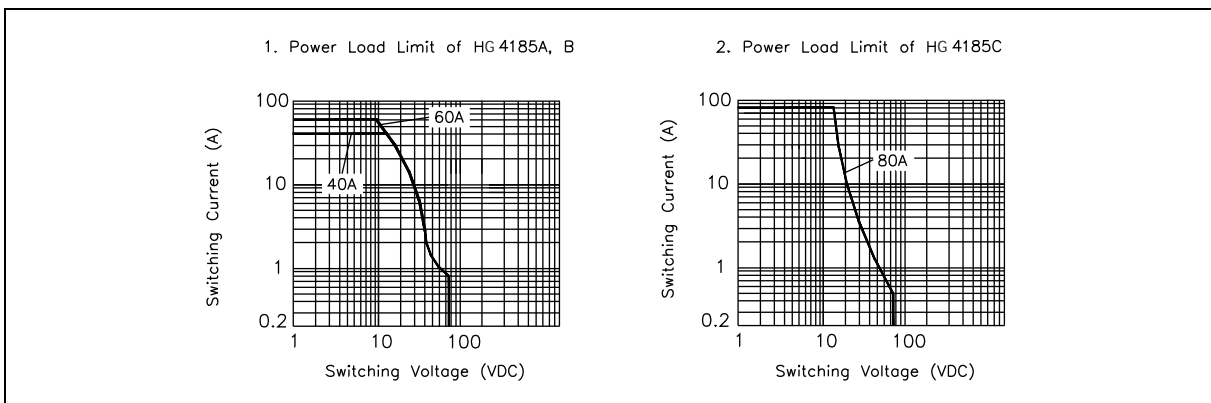

HG4185A/B/C

OVERALL DIMENSIONS, OPTIONAL COVERS, TERMINAL LAYOUTS, MOUNTING HOLES AND WIRING DIAGRAMS (mm)

Overall Dimensions, Plug-In Type

HG4185A, HG4185B

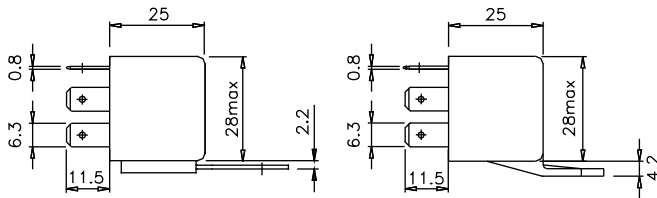

HG4185C

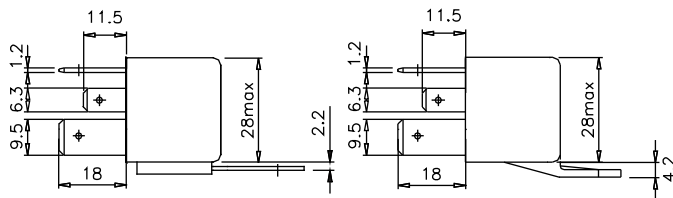

1 Form A (1H)

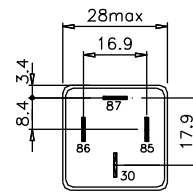

1 Form A (1HS)
1 Form C (1Z)

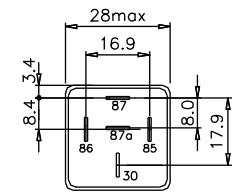

1 Form A (1H)

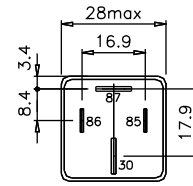

1 Form C (1Z)

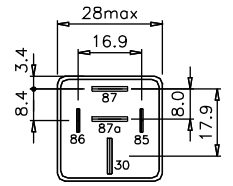

Optional Covers

9 - Molded Bracket

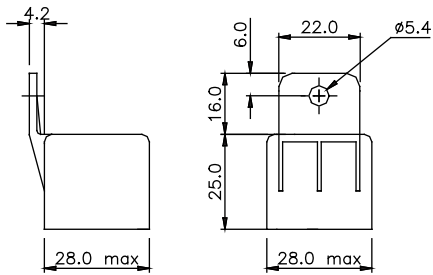

9S1 - Skirted Cover + Metal Bracket
9S2 - Skirted Cover + Bent Metal Bracket

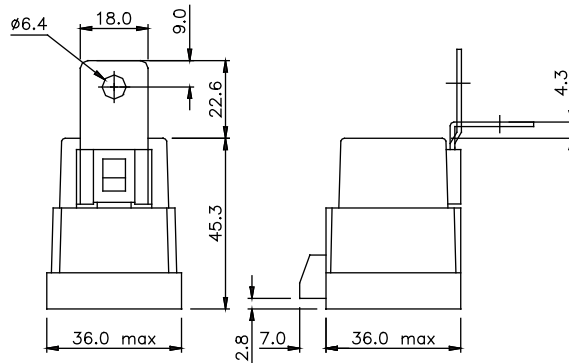

9M1 - Metal Bracket
9M2 - Bent Metal Bracket

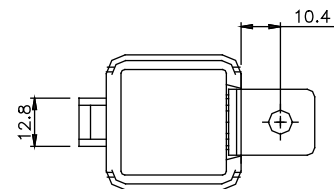
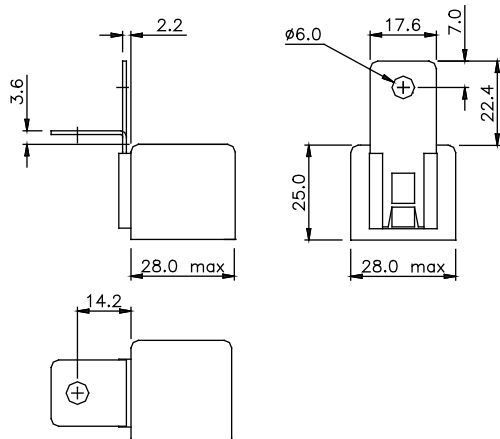

HG4185A/B/C

Overall Dimensions, PCB Type

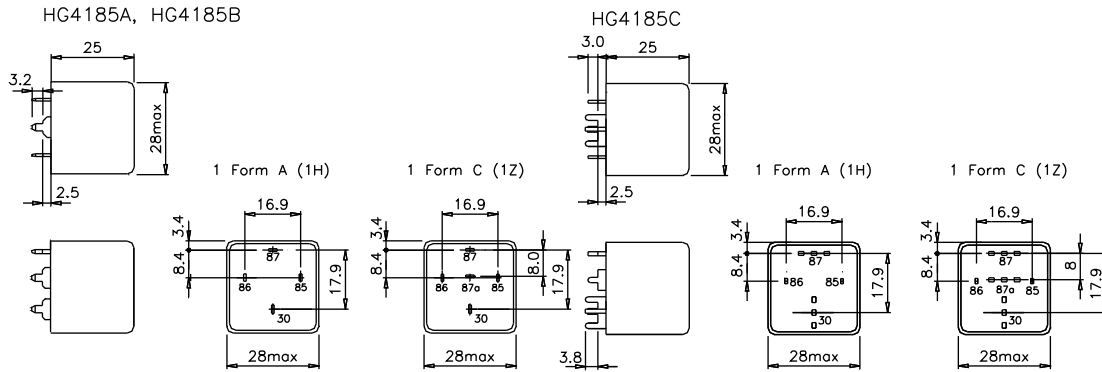

PCB Type Mounting Holes (Bottom View)

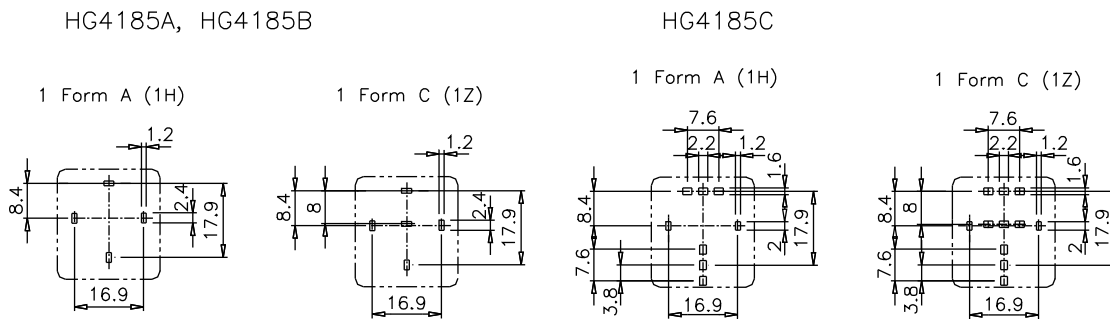

Wiring Diagrams

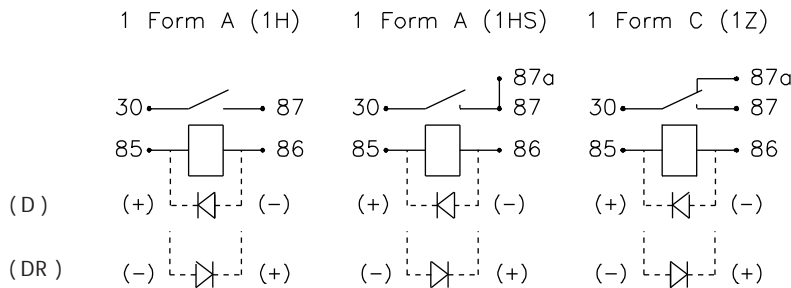

NOTES

1. All parameters, unless otherwise specified, are measured at ambient temperature 23°C.
2. Maximum make current refers to inrush current of lamp load.
3. At ambient temperature of 85°C, maximum allowable voltage should be reduced to 72%.
4. Electrical life obtained at resistive or inductive load at 20A, 15 VDC for HG4185A; 40A, 15VDC for HG4185B; 80A, 15VDC for HG4185C with suitable arc-suppression circuit attached with operating frequency of 1 ops/sec.
5. Custom-made services available with operational quantity. Please let us know your special requirements.
6. Specifications subject to change without prior notice.

T Y H Enterprise Limited
 Room 1620B, Nan Fung Centre
 264-298 Castle Peak Road
 Tsuen Wan, N.T.
 Hong Kong
 Tel: 852-2416-0132
 Fax: 852-2413-6229
<http://www.tyhhk.com>
 email: info@tyhhk.com

Plant: Shanghai Hi-Gradex Relay Mfg. Co., Ltd
 918 Shixin Road
 Airport Town
 Pudong New Area
 Shanghai 201202
 China
 Tel: 86-21-6299-5619 / -5877
 Fax: 86-21-6299-5619
 email: tyhesh@online.sh.cn